



2D | 3D | 4D | 5D

MAXPRO DRILL

Maximum performance to a great drilling experience

DRILLING

Indexable system



SINCE 1916

XCS TOOLHOLDERS

Palbit's MaxPro Drill indexable drilling tool is a versatile and high-performance tool designed for drilling operations on various surfaces.

With cutting diameters ranging from $\text{\O}14\text{mm}$ to $\text{\O}60\text{mm}$ and drilling lengths from 2xDc to 5xDc, the MaxPro Drill is capable of handling a wide range of drilling requirements.

Its specialized cutting inserts allow for efficient and precise drilling on flat surfaces, inclined surfaces, as well as for making crossing holes, chain drilling, and stack drilling.

Whether drilling through multiple layers of materials or working on complex drilling projects, the MaxPro Drill offers reliable performance and exceptional results.

Its modular design and quick-change inserts also help to reduce tool changeover times and increase productivity.



SOKX & XOKX INSERTS



SOKX
Outer Insert



SOKX-MP
Outer Insert

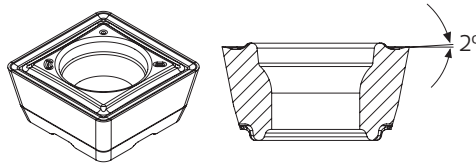

SOKX-MS
Outer Insert

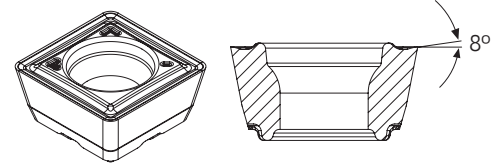

XOKX
Inner Insert



XOKX-MP
Inner Insert

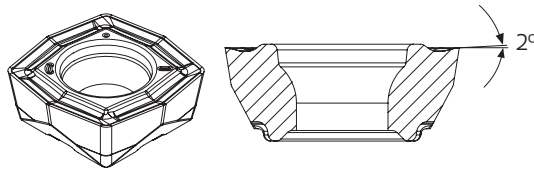

XOKX-MS
Inner Insert

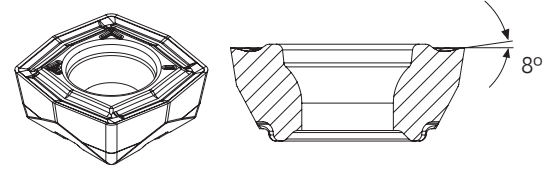

APPLICABILITY

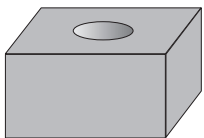

Flat Surface

MaxPro Drill is designed to perform efficient and precise drilling on flat surfaces. Its cutting inserts are carefully selected to deliver optimal performance on various materials.

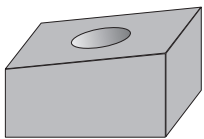

Inclined Surface

The MaxPro Drill is also suitable for drilling on inclined surfaces. Its specialized inserts can handle the cutting forces and torque required to cut through materials at different angles.

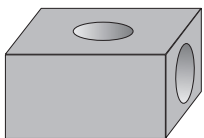

Crossing Hole

With its precise positioning and excellent stability, MaxPro Drill is ideal for making crossing holes. It allows for accurate and efficient drilling operations without compromising the quality of the finished product.

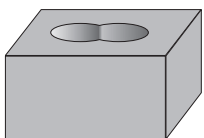

Chain Drilling

The MaxPro Drill is capable of performing chain drilling operations, thanks to its cutting-edge design and high-quality cutting inserts. It allows for faster drilling speeds and improved productivity, while also reducing tool changeover times.

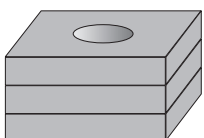

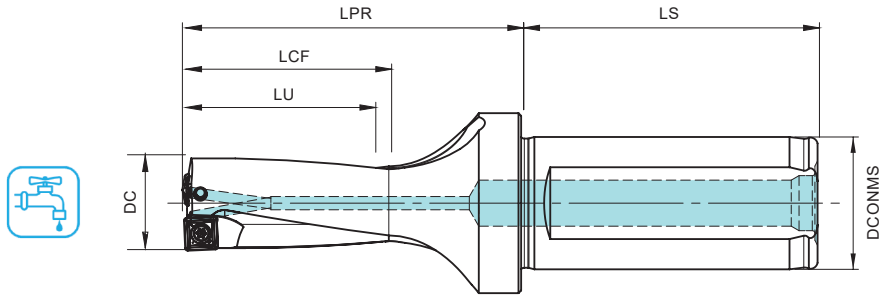

Stack Drilling

The MaxPro Drill is also well-suited for stack drilling applications. Its modular design and reliable performance make it an excellent choice for drilling multiple layers of materials with precision and ease.



DC	DCONMS	BP / SP	2D		
			DC	Drill tolerance	Hole tolerance
20	50	PT - 1/8	14-29,5	0/-0,15	-0,10/+0,20
25	56	PT - 1/8	30-42	0/-0,15	-0,10/+0,25
32	60	PT - 1/4	43-50	0/-0,15	-0,10/+0,28

Order code Código	Reference Referência Referencia	Dimensions Dimensões Dimensiones (mm)					Inner Insert	Outer Insert	Insert Screw 	Torx key 	Stock
		DC	DCONMS	LU	LCF	LPR					
184316800	XCS 14020-2D	14,0	20	28	31	51	XOKX 050204	SOKX 050204	P02004IP	XT06IP	☺
184316900	XCS 14520-2D	14,5	20	29	32	52	XOKX 050204	SOKX 050204	P02004IP	XT06IP	☺
184317000	XCS 15020-2D	15,0	20	30	33	53	XOKX 050204	SOKX 050204	P02004IP	XT06IP	☺
184317100	XCS 15520-2D	15,5	20	31	34	54	XOKX 050204	SOKX 050204	P02004IP	XT06IP	☺
184317200	XCS 16020-2D	16,0	20	32	35	55	XOKX 050204	SOKX 050204	P02004IP	XT06IP	☺
184317300	XCS 16525-2D	16,5	25	33	36	61	XOKX 060204	SOKX 060205	P02205IP	XT06IP	☺
184317400	XCS 17025-2D	17,0	25	34	37	62	XOKX 060204	SOKX 060205	P02205IP	XT06IP	☺
184317500	XCS 17525-2D	17,5	25	35	38	63	XOKX 060204	SOKX 060205	P02205IP	XT06IP	☺
184317600	XCS 18025-2D	18,0	25	36	39	64	XOKX 060204	SOKX 060205	P02205IP	XT06IP	☺
184317700	XCS 18525-2D	18,5	25	37	40	65	XOKX 060204	SOKX 060205	P02205IP	XT06IP	☺
184317800	XCS 19025-2D	19,0	25	38	41	66	XOKX 060204	SOKX 060205	P02205IP	XT06IP	☺
184317900	XCS 19525-2D	19,5	25	39	42	67	XOKX 060204	SOKX 060205	P02205IP	XT06IP	☺
184318000	XCS 20025-2D	20,0	25	40	43	68	XOKX 07T205	SOKX 07T208	P02507IP	XT08IP	☺
184318100	XCS 20525-2D	20,5	25	41	44	69	XOKX 07T205	SOKX 07T208	P02507IP	XT08IP	☺
184318200	XCS 21025-2D	21,0	25	42	45	70	XOKX 07T205	SOKX 07T208	P02507IP	XT08IP	☺
184318300	XCS 21525-2D	21,5	25	43	46	71	XOKX 07T205	SOKX 07T208	P02507IP	XT08IP	☺
184318400	XCS 22025-2D	22,0	25	44	47	72	XOKX 07T205	SOKX 07T208	P02507IP	XT08IP	☺
184318500	XCS 22525-2D	22,5	25	45	48	73	XOKX 07T205	SOKX 07T208	P02507IP	XT08IP	☺
184318600	XCS 23025-2D	23,0	25	46	49	74	XOKX 07T205	SOKX 07T208	P02507IP	XT08IP	☺
184318700	XCS 23525-2D	23,5	25	47	50	75	XOKX 07T205	SOKX 07T208	P02507IP	XT08IP	☺



☺ Stock item | Produto de stock | Itens de stock

○ Available under request | Disponível sobre consulta | Disponible bajo consulta

Continue next page

XCS 2D

Jet drills | Brocas jet | Brocas jet



Order code Código	Reference Referência Referencia	Dimensions Dimensões Dimensiones (mm)					Inner Insert	Outer Insert	Insert Screw 	Torx key 	Stock
		DC	DCONMS	LU	LCF	LPR					
184318800	XCS 24032-2D	24,0	32	48	51	81	XOKX 090305	SOKX 090308	P03007IP	XT08IP	📦
184318900	XCS 24532-2D	24,5	32	49	52	82	XOKX 090305	SOKX 090308	P03007IP	XT08IP	📦
184319000	XCS 25032-2D	25,0	32	50	53	83	XOKX 090305	SOKX 090308	P03007IP	XT08IP	📦
184319100	XCS 25532-2D	25,5	32	51	54	84	XOKX 090305	SOKX 090308	P03007IP	XT08IP	📦
184319200	XCS 26032-2D	26,0	32	52	55	85	XOKX 090305	SOKX 090308	P03007IP	XT08IP	📦
184319300	XCS 26532-2D	26,5	32	53	56	86	XOKX 090305	SOKX 090308	P03007IP	XT08IP	📦
184319400	XCS 27032-2D	27,0	32	54	57	87	XOKX 090305	SOKX 090308	P03007IP	XT08IP	📦
184319500	XCS 27532-2D	27,5	32	55	58	88	XOKX 090305	SOKX 090308	P03007IP	XT08IP	📦
184319600	XCS 28032-2D	28,0	32	56	59	89	XOKX 090305	SOKX 090308	P03007IP	XT08IP	📦
184319700	XCS 28532-2D	28,5	32	57	60	90	XOKX 090305	SOKX 090308	P03007IP	XT08IP	📦
184319800	XCS 29032-2D	29,0	32	58	61	91	XOKX 090305	SOKX 090308	P03007IP	XT08IP	📦
184319900	XCS 29532-2D	29,5	32	59	62	92	XOKX 090305	SOKX 090308	P03007IP	XT08IP	📦
184320000	XCS 30032-2D	30,0	32	62	65	95	XOKX 11T306	SOKX 11T308	P03508IP	XT15IP-S35	📦
184320100	XCS 31032-2D	31,0	32	64	67	97	XOKX 11T306	SOKX 11T308	P03508IP	XT15IP-S35	📦
184320200	XCS 32032-2D	32,0	32	66	69	99	XOKX 11T306	SOKX 11T308	P03508IP	XT15IP-S35	📦
184320300	XCS 33032-2D	33,0	32	68	71	101	XOKX 11T306	SOKX 11T308	P03508IP	XT15IP-S35	📦
184320400	XCS 34032-2D	34,0	32	70	73	103	XOKX 11T306	SOKX 11T308	P03508IP	XT15IP-S35	📦
184320500	XCS 35032-2D	35,0	32	72	75	105	XOKX 11T306	SOKX 11T308	P03508IP	XT15IP-S35	📦
184320600	XCS 36040-2D	36,0	40	74	77	112	XOKX 130406	SOKX 130410	P04010IP	XT15IP-S35	📦
184320700	XCS 37040-2D	37,0	40	76	79	114	XOKX 130406	SOKX 130410	P04010IP	XT15IP-S35	📦
184320800	XCS 38040-2D	38,0	40	78	81	116	XOKX 130406	SOKX 130410	P04010IP	XT15IP-S35	📦
184320900	XCS 39040-2D	39,0	40	80	83	118	XOKX 130406	SOKX 130410	P04010IP	XT15IP-S35	📦
184321000	XCS 40040-2D	40,0	40	82	85	120	XOKX 130406	SOKX 130410	P04010IP	XT15IP-S35	📦
184321100	XCS 41040-2D	41,0	40	84	87	122	XOKX 130406	SOKX 130410	P04010IP	XT15IP-S35	📦
184321200	XCS 42040-2D	42,0	40	86	89	124	XOKX 130406	SOKX 130410	P04010IP	XT15IP-S35	📦
184321300	XCS 43040-2D	43,0	40	88	91	126	XOKX 150508	SOKX 150510	P05013IP	XT20IP-S40	📦
184321400	XCS 44040-2D	44,0	40	90	93	128	XOKX 150508	SOKX 150510	P05013IP	XT20IP-S40	📦
184321500	XCS 45040-2D	45,0	40	92	95	130	XOKX 150508	SOKX 150510	P05013IP	XT20IP-S40	📦
184321600	XCS 46040-2D	46,0	40	94	97	132	XOKX 150508	SOKX 150510	P05013IP	XT20IP-S40	📦
184321700	XCS 47040-2D	47,0	40	96	99	134	XOKX 150508	SOKX 150510	P05013IP	XT20IP-S40	📦
184321800	XCS 48040-2D	48,0	40	98	101	136	XOKX 150508	SOKX 150510	P05013IP	XT20IP-S40	📦
184321900	XCS 49040-2D	49,0	40	100	103	138	XOKX 150508	SOKX 150510	P05013IP	XT20IP-S40	📦
184322000	XCS 50040-2D	50,0	40	102	105	140	XOKX 150508	SOKX 150510	P05013IP	XT20IP-S40	📦
184340200	XCS 51040-2D	51,0	40	104	107	142	XOKX 180508	SOKX 180510	P05013IP	XT20IP-S40	📦
184340300	XCS 52040-2D	52,0	40	106	109	144	XOKX 180508	SOKX 180510	P05013IP	XT20IP-S40	📦
184340400	XCS 53040-2D	53,0	40	108	111	146	XOKX 180508	SOKX 180510	P05013IP	XT20IP-S40	📦
184340500	XCS 54040-2D	54,0	40	110	113	148	XOKX 180508	SOKX 180510	P05013IP	XT20IP-S40	📦
184340600	XCS 55040-2D	55,0	40	112	115	150	XOKX 180508	SOKX 180510	P05013IP	XT20IP-S40	📦
184340700	XCS 56040-2D	56,0	40	114	117	152	XOKX 180508	SOKX 180510	P05013IP	XT20IP-S40	📦
184340800	XCS 57040-2D	57,0	40	116	119	154	XOKX 180508	SOKX 180510	P05013IP	XT20IP-S40	📦
184340900	XCS 58040-2D	58,0	40	118	121	156	XOKX 180508	SOKX 180510	P05013IP	XT20IP-S40	📦
184341000	XCS 59040-2D	59,0	40	120	123	158	XOKX 180508	SOKX 180510	P05013IP	XT20IP-S40	📦
184341100	XCS 60040-2D	60,00	40	122	125	160	XOKX 180508	SOKX 180510	P05013IP	XT20IP-S40	📦

📦 Stock item | Produto de stock | Itens de stock

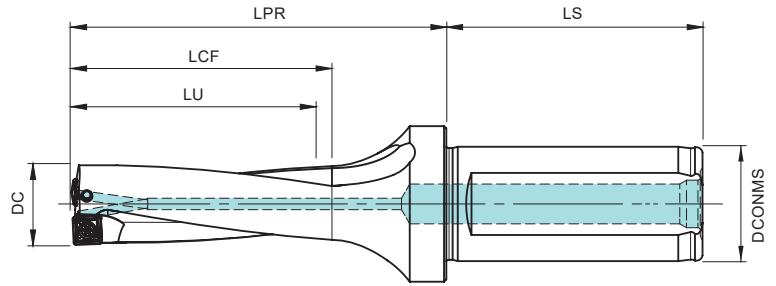
○ Available under request | Disponível sobre consulta | Disponible bajo consulta



DC	DCONMS	BP / SP	3D		
			DC	Drill tolerance	Hole tolerance
20	50	PT - 1/8	14-29,5	0/-0,15	-0,10/+0,20
25	56	PT - 1/8	30-42	0/-0,15	-0,10/+0,25
32	60	PT - 1/4	43-50	0/-0,15	-0,10/+0,28

Order code Código	Reference Referência Referencia	Dimensions Dimensões Dimensiones (mm)					Inner Insert	Outer Insert	Insert Screw 	Torx key 	Stock
		DC	DCONMS	LU	LCF	LPR					
184322100	XCS 14020-3D	14,0	20	42	45	65	XOKX 050204	SOKX 050204	P02004IP	XT06IP	☺
184322200	XCS 14520-3D	14,5	20	44	47	67	XOKX 050204	SOKX 050204	P02004IP	XT06IP	☺
184322300	XCS 15020-3D	15,0	20	45	48	68	XOKX 050204	SOKX 050204	P02004IP	XT06IP	☺
184322400	XCS 15520-3D	15,5	20	47	50	70	XOKX 050204	SOKX 050204	P02004IP	XT06IP	☺
184322500	XCS 16020-3D	16,0	20	48	51	71	XOKX 050204	SOKX 050204	P02004IP	XT06IP	☺
184322600	XCS 16525-3D	16,5	25	50	53	78	XOKX 060204	SOKX 060205	P02205IP	XT06IP	☺
184322700	XCS 17025-3D	17,0	25	51	54	79	XOKX 060204	SOKX 060205	P02205IP	XT06IP	☺
184322800	XCS 17525-3D	17,5	25	53	56	81	XOKX 060204	SOKX 060205	P02205IP	XT06IP	☺
184322900	XCS 18025-3D	18,0	25	54	57	82	XOKX 060204	SOKX 060205	P02205IP	XT06IP	☺
184323000	XCS 18525-3D	18,5	25	56	59	84	XOKX 060204	SOKX 060205	P02205IP	XT06IP	☺
184323100	XCS 19025-3D	19,0	25	57	60	85	XOKX 060204	SOKX 060205	P02205IP	XT06IP	☺
184323200	XCS 19525-3D	19,5	25	59	62	87	XOKX 060204	SOKX 060205	P02205IP	XT06IP	☺
184323300	XCS 20025-3D	20,0	25	60	63	88	XOKX 07T205	SOKX 07T208	P02507IP	XT08IP	☺
184323400	XCS 20525-3D	20,5	25	62	65	90	XOKX 07T205	SOKX 07T208	P02507IP	XT08IP	☺
184323500	XCS 21025-3D	21,0	25	63	66	91	XOKX 07T205	SOKX 07T208	P02507IP	XT08IP	☺
184323600	XCS 21525-3D	21,5	25	65	68	93	XOKX 07T205	SOKX 07T208	P02507IP	XT08IP	☺
184323700	XCS 22025-3D	22,0	25	66	69	94	XOKX 07T205	SOKX 07T208	P02507IP	XT08IP	☺
184323800	XCS 22525-3D	22,5	25	68	71	96	XOKX 07T205	SOKX 07T208	P02507IP	XT08IP	☺
184323900	XCS 23025-3D	23,0	25	69	72	97	XOKX 07T205	SOKX 07T208	P02507IP	XT08IP	☺
184324000	XCS 23525-3D	23,5	25	71	74	99	XOKX 07T205	SOKX 07T208	P02507IP	XT08IP	☺



☺ Stock item | Produto de stock | Itens de stock

○ Available under request | Disponível sobre consulta | Disponible bajo consulta

Continue next page

XCS 3D

Jet drills | Brocas jet | Brocas jet







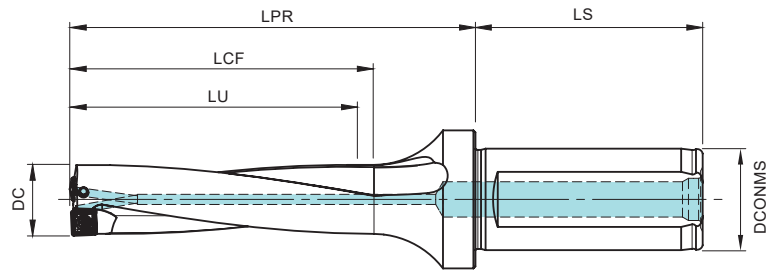















Order code Código	Reference Referência Referencia	Dimensions Dimensões Dimensiones (mm)					Inner Insert	Outer Insert	Insert Screw 	Torx key 	Stock
		DC	DCONMS	LU	LCF	LPR					
184324100	XCS 24032-3D	24,0	32	72	75	105	XOKX 090305	SOKX 090308	P03007IP	XT08IP	📦
184324200	XCS 24532-3D	24,5	32	74	77	107	XOKX 090305	SOKX 090308	P03007IP	XT08IP	📦
184324300	XCS 25032-3D	25,0	32	75	78	108	XOKX 090305	SOKX 090308	P03007IP	XT08IP	📦
184324400	XCS 25532-3D	25,5	32	77	80	110	XOKX 090305	SOKX 090308	P03007IP	XT08IP	📦
184324500	XCS 26032-3D	26,0	32	78	81	111	XOKX 090305	SOKX 090308	P03007IP	XT08IP	📦
184324600	XCS 26532-3D	26,5	32	80	83	113	XOKX 090305	SOKX 090308	P03007IP	XT08IP	📦
184324700	XCS 27032-3D	27,0	32	81	84	114	XOKX 090305	SOKX 090308	P03007IP	XT08IP	📦
184324800	XCS 27532-3D	27,5	32	83	86	116	XOKX 090305	SOKX 090308	P03007IP	XT08IP	📦
184324900	XCS 28032-3D	28,0	32	84	87	117	XOKX 090305	SOKX 090308	P03007IP	XT08IP	📦
184325000	XCS 28532-3D	28,5	32	86	89	119	XOKX 090305	SOKX 090308	P03007IP	XT08IP	📦
184325100	XCS 29032-3D	29,0	32	87	90	120	XOKX 090305	SOKX 090308	P03007IP	XT08IP	📦
184325200	XCS 29532-3D	29,5	32	89	92	122	XOKX 090305	SOKX 090308	P03007IP	XT08IP	📦
184325300	XCS 30032-3D	30,0	32	92	95	125	XOKX 11T306	SOKX 11T308	P03508IP	XT15IP-S35	📦
184325400	XCS 31032-3D	31,0	32	95	98	128	XOKX 11T306	SOKX 11T308	P03508IP	XT15IP-S35	📦
184325500	XCS 32032-3D	32,0	32	98	101	131	XOKX 11T306	SOKX 11T308	P03508IP	XT15IP-S35	📦
184325600	XCS 33032-3D	33,0	32	101	104	134	XOKX 11T306	SOKX 11T308	P03508IP	XT15IP-S35	📦
184325700	XCS 34032-3D	34,0	32	104	107	137	XOKX 11T306	SOKX 11T308	P03508IP	XT15IP-S35	📦
184325800	XCS 35032-3D	35,0	32	107	110	140	XOKX 11T306	SOKX 11T308	P03508IP	XT15IP-S35	📦
184325900	XCS 36040-3D	36,0	40	110	113	148	XOKX 130406	SOKX 130410	P04010IP	XT15IP-S35	📦
184326000	XCS 37040-3D	37,0	40	113	116	151	XOKX 130406	SOKX 130410	P04010IP	XT15IP-S35	📦
184326100	XCS 38040-3D	38,0	40	116	119	154	XOKX 130406	SOKX 130410	P04010IP	XT15IP-S35	📦
184326200	XCS 39040-3D	39,0	40	119	122	157	XOKX 130406	SOKX 130410	P04010IP	XT15IP-S35	📦
184326300	XCS 40040-3D	40,0	40	122	125	160	XOKX 130406	SOKX 130410	P04010IP	XT15IP-S35	📦
184326400	XCS 41040-3D	41,0	40	125	128	163	XOKX 130406	SOKX 130410	P04010IP	XT15IP-S35	📦
184326500	XCS 42040-3D	42,0	40	128	131	166	XOKX 130406	SOKX 130410	P04010IP	XT15IP-S35	📦
184326600	XCS 43040-3D	43,0	40	131	134	169	XOKX 150508	SOKX 150510	P05013IP	XT20IP-S40	📦
184326700	XCS 44040-3D	44,0	40	134	137	172	XOKX 150508	SOKX 150510	P05013IP	XT20IP-S40	📦
184310700	XCS 45040-3D	45,0	40	137	140	175	XOKX 150508	SOKX 150510	P05013IP	XT20IP-S40	📦
184310800	XCS 46040-3D	46,0	40	140	143	178	XOKX 150508	SOKX 150510	P05013IP	XT20IP-S40	📦
184326800	XCS 47040-3D	47,0	40	143	146	181	XOKX 150508	SOKX 150510	P05013IP	XT20IP-S40	📦
184326900	XCS 48040-3D	48,0	40	146	149	184	XOKX 150508	SOKX 150510	P05013IP	XT20IP-S40	📦
184327000	XCS 49040-3D	49,0	40	149	152	187	XOKX 150508	SOKX 150510	P05013IP	XT20IP-S40	📦
184327100	XCS 50040-3D	50,0	40	152	155	190	XOKX 150508	SOKX 150510	P05013IP	XT20IP-S40	📦
184341200	XCS 51040-3D	51,0	40	155	158	193	XOKX 180508	SOKX 180510	P05013IP	XT20IP-S40	📦
184341300	XCS 52040-3D	52,0	40	158	161	196	XOKX 180508	SOKX 180510	P05013IP	XT20IP-S40	📦
184341400	XCS 53040-3D	53,0	40	161	164	199	XOKX 180508	SOKX 180510	P05013IP	XT20IP-S40	📦
184341500	XCS 54040-3D	54,0	40	164	167	202	XOKX 180508	SOKX 180510	P05013IP	XT20IP-S40	📦
184341600	XCS 55040-3D	55,0	40	167	170	205	XOKX 180508	SOKX 180510	P05013IP	XT20IP-S40	📦
184341700	XCS 56040-3D	56,0	40	170	173	208	XOKX 180508	SOKX 180510	P05013IP	XT20IP-S40	📦
184341800	XCS 57040-3D	57,0	40	173	176	211	XOKX 180508	SOKX 180510	P05013IP	XT20IP-S40	📦
184341900	XCS 58040-3D	58,0	40	176	179	214	XOKX 180508	SOKX 180510	P05013IP	XT20IP-S40	📦
184342000	XCS 59040-3D	59,0	40	179	182	217	XOKX 180508	SOKX 180510	P05013IP	XT20IP-S40	📦
184342100	XCS 60040-3D	60,0	40	182	185	220	XOKX 180508	SOKX 180510	P05013IP	XT20IP-S40	📦

📦 Stock item | Produto de stock | Itens de stock

○ Available under request | Disponível sobre consulta | Disponible bajo consulta



DC	DCONMS	BP / SP	4D		
			DC	Drill tolerance	Hole tolerance
20	50	PT - 1/8	14-29,5	0/-0,15	-0,05/+0,25
25	56	PT - 1/8	30-42	0/-0,15	-0,05/+0,30
32	60	PT - 1/4	43-50	0/-0,15	-0,05/+0,33

Order code Código	Reference Referência Referencia	Dimensions Dimensões Dimensiones (mm)					Inner Insert	Outer Insert	Insert Screw 	Torx key 	Stock 
		DC	DCONMS	LU	LCF	LPR					
184327200	XCS 14020-4D	14,0	20	56	59	79	XOKX 050204	SOKX 050204	P02004IP	XT06IP	
184327300	XCS 14520-4D	14,5	20	58	61	81	XOKX 050204	SOKX 050204	P02004IP	XT06IP	
184327400	XCS 15020-4D	15,0	20	60	63	83	XOKX 050204	SOKX 050204	P02004IP	XT06IP	
184327500	XCS 15520-4D	15,5	20	62	65	85	XOKX 050204	SOKX 050204	P02004IP	XT06IP	
184327600	XCS 16020-4D	16,0	20	64	67	87	XOKX 050204	SOKX 050204	P02004IP	XT06IP	
184327700	XCS 16525-4D	16,5	25	66	69	94	XOKX 060204	SOKX 060205	P02205IP	XT06IP	
184327800	XCS 17025-4D	17,0	25	68	71	96	XOKX 060204	SOKX 060205	P02205IP	XT06IP	
184327900	XCS 17525-4D	17,5	25	70	73	98	XOKX 060204	SOKX 060205	P02205IP	XT06IP	
184328000	XCS 18025-4D	18,0	25	72	75	100	XOKX 060204	SOKX 060205	P02205IP	XT06IP	
184328100	XCS 18525-4D	18,5	25	74	77	102	XOKX 060204	SOKX 060205	P02205IP	XT06IP	
184328200	XCS 19025-4D	19,0	25	76	79	104	XOKX 060204	SOKX 060205	P02205IP	XT06IP	
184328300	XCS 19525-4D	19,5	25	78	81	106	XOKX 060204	SOKX 060205	P02205IP	XT06IP	
184328400	XCS 20025-4D	20,0	25	80	83	108	XOKX 07T205	SOKX 07T208	P02507IP	XT08IP	
184328500	XCS 20525-4D	20,5	25	82	85	110	XOKX 07T205	SOKX 07T208	P02507IP	XT08IP	
184328600	XCS 21025-4D	21,0	25	84	87	112	XOKX 07T205	SOKX 07T208	P02507IP	XT08IP	
184328700	XCS 21525-4D	21,5	25	86	89	114	XOKX 07T205	SOKX 07T208	P02507IP	XT08IP	
184328800	XCS 22025-4D	22,0	25	88	91	116	XOKX 07T205	SOKX 07T208	P02507IP	XT08IP	
184328900	XCS 22525-4D	22,5	25	90	93	118	XOKX 07T205	SOKX 07T208	P02507IP	XT08IP	
184329000	XCS 23025-4D	23,0	25	92	95	120	XOKX 07T205	SOKX 07T208	P02507IP	XT08IP	
184329100	XCS 23525-4D	23,5	25	94	97	122	XOKX 07T205	SOKX 07T208	P02507IP	XT08IP	



 Stock item | Produto de stock | Itens de stock

 Available under request | Disponível sobre consulta | Disponible bajo consulta

Continue next page

XCS 4D

Jet drills | Brocas jet | Brocas jet



Order code Código	Reference Referência Referencia	Dimensions Dimensões Dimensiones (mm)					Inner Insert	Outer Insert	Insert Screw 	Torx key 	Stock
		DC	DCONMS	LU	LCF	LPR					
184329200	XCS 24032-4D	24,0	32	96	99	129	XOKX 090305	SOKX 090308	P03007IP	XT08IP	📦
184329300	XCS 24532-4D	24,5	32	98	101	131	XOKX 090305	SOKX 090308	P03007IP	XT08IP	📦
184329400	XCS 25032-4D	25,0	32	100	103	133	XOKX 090305	SOKX 090308	P03007IP	XT08IP	📦
184329500	XCS 25532-4D	25,5	32	102	105	135	XOKX 090305	SOKX 090308	P03007IP	XT08IP	📦
184329600	XCS 26032-4D	26,0	32	104	107	137	XOKX 090305	SOKX 090308	P03007IP	XT08IP	📦
184329700	XCS 26532-4D	26,5	32	106	109	139	XOKX 090305	SOKX 090308	P03007IP	XT08IP	📦
184329800	XCS 27032-4D	27,0	32	108	111	141	XOKX 090305	SOKX 090308	P03007IP	XT08IP	📦
184329900	XCS 27532-4D	27,5	32	110	113	143	XOKX 090305	SOKX 090308	P03007IP	XT08IP	📦
184330000	XCS 28032-4D	28,0	32	112	115	145	XOKX 090305	SOKX 090308	P03007IP	XT08IP	📦
184330100	XCS 28532-4D	28,5	32	114	117	147	XOKX 090305	SOKX 090308	P03007IP	XT08IP	📦
184330200	XCS 29032-4D	29,0	32	116	119	149	XOKX 090305	SOKX 090308	P03007IP	XT08IP	📦
184330300	XCS 29532-4D	29,5	32	118	121	151	XOKX 090305	SOKX 090308	P03007IP	XT08IP	📦
184330400	XCS 30032-4D	30,0	32	122	125	155	XOKX 11T306	SOKX 11T308	P03508IP	XT15IP-S35	📦
184330500	XCS 31032-4D	31,0	32	126	129	159	XOKX 11T306	SOKX 11T308	P03508IP	XT15IP-S35	📦
184330600	XCS 32032-4D	32,0	32	130	133	163	XOKX 11T306	SOKX 11T308	P03508IP	XT15IP-S35	📦
184330700	XCS 33032-4D	33,0	32	134	137	167	XOKX 11T306	SOKX 11T308	P03508IP	XT15IP-S35	📦
184330800	XCS 34032-4D	34,0	32	138	141	171	XOKX 11T306	SOKX 11T308	P03508IP	XT15IP-S35	📦
184330900	XCS 35032-4D	35,0	32	142	145	175	XOKX 11T306	SOKX 11T308	P03508IP	XT15IP-S35	📦
184331000	XCS 36040-4D	36,0	40	146	149	184	XOKX 130406	SOKX 130410	P04010IP	XT15IP-S35	📦
184331100	XCS 37040-4D	37,0	40	150	153	188	XOKX 130406	SOKX 130410	P04010IP	XT15IP-S35	📦
184331200	XCS 38040-4D	38,0	40	154	157	192	XOKX 130406	SOKX 130410	P04010IP	XT15IP-S35	📦
184331300	XCS 39040-4D	39,0	40	158	161	196	XOKX 130406	SOKX 130410	P04010IP	XT15IP-S35	📦
184331400	XCS 40040-4D	40,0	40	162	165	200	XOKX 130406	SOKX 130410	P04010IP	XT15IP-S35	📦
184331500	XCS 41040-4D	41,0	40	166	169	204	XOKX 130406	SOKX 130410	P04010IP	XT15IP-S35	📦
184331600	XCS 42040-4D	42,0	40	170	173	208	XOKX 130406	SOKX 130410	P04010IP	XT15IP-S35	📦
184331700	XCS 43040-4D	43,0	40	174	177	212	XOKX 150508	SOKX 150510	P05013IP	XT20IP-S40	📦
184331800	XCS 44040-4D	44,0	40	178	181	216	XOKX 150508	SOKX 150510	P05013IP	XT20IP-S40	📦
184331900	XCS 45040-4D	45,0	40	182	185	220	XOKX 150508	SOKX 150510	P05013IP	XT20IP-S40	📦
184332000	XCS 46040-4D	46,0	40	186	189	224	XOKX 150508	SOKX 150510	P05013IP	XT20IP-S40	📦
184332100	XCS 47040-4D	47,0	40	190	193	228	XOKX 150508	SOKX 150510	P05013IP	XT20IP-S40	📦
184332200	XCS 48040-4D	48,0	40	194	197	232	XOKX 150508	SOKX 150510	P05013IP	XT20IP-S40	📦
184332300	XCS 49040-4D	49,0	40	198	201	236	XOKX 150508	SOKX 150510	P05013IP	XT20IP-S40	📦
184332400	XCS 50040-4D	50,0	40	202	205	240	XOKX 150508	SOKX 150510	P05013IP	XT20IP-S40	📦
184342200	XCS 51040-4D	51,0	40	204	209	244	XOKX 180508	SOKX 180510	P05013IP	XT20IP-S40	📦
184342300	XCS 52040-4D	52,0	40	208	213	248	XOKX 180508	SOKX 180510	P05013IP	XT20IP-S40	📦
184342400	XCS 53040-4D	53,0	40	212	217	252	XOKX 180508	SOKX 180510	P05013IP	XT20IP-S40	📦
184342500	XCS 54040-4D	54,0	40	216	221	256	XOKX 180508	SOKX 180510	P05013IP	XT20IP-S40	📦
184342600	XCS 55040-4D	55,0	40	220	225	260	XOKX 180508	SOKX 180510	P05013IP	XT20IP-S40	📦
184342700	XCS 56040-4D	56,0	40	224	229	264	XOKX 180508	SOKX 180510	P05013IP	XT20IP-S40	📦
184342800	XCS 57040-4D	57,0	40	228	233	264	XOKX 180508	SOKX 180510	P05013IP	XT20IP-S40	📦
184342900	XCS 58040-4D	58,0	40	232	237	272	XOKX 180508	SOKX 180510	P05013IP	XT20IP-S40	📦
184343000	XCS 59040-4D	59,0	40	236	241	276	XOKX 180508	SOKX 180510	P05013IP	XT20IP-S40	📦
184343100	XCS 60040-4D	60,0	40	240	245	280	XOKX 180508	SOKX 180510	P05013IP	XT20IP-S40	📦

📦 Stock item | Produto de stock | Itens de stock

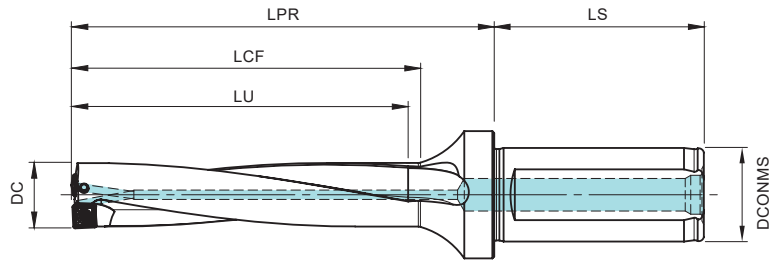
○ Available under request | Disponível sobre consulta | Disponible bajo consulta



DCONMS	LS	BP / SP	5D		
			DC	Drill tolerance	Hole tolerance
20	50	PT - 1/8	14-29,5	0/-0,15	-0,05/+0,25
25	56	PT - 1/8	30-42	0/-0,15	-0,05/+0,30
32	60	PT - 1/4	43-50	0/-0,15	-0,05/+0,33

Order code Código	Reference Referência Referencia	Dimensions Dimensões Dimensiones (mm)					Inner Insert	Outer Insert	Insert Screw 	Torx key 	Stock
		DC	DCONMS	LU	LCF	LPR					
184332500	XCS 14020-5D	14,0	20	70	73	88	XOKX 050204	SOKX 050204	P02004IP	XT06IP	☺
184332600	XCS 14520-5D	14,5	20	73	76	91	XOKX 050204	SOKX 050204	P02004IP	XT06IP	☺
184332700	XCS 15020-5D	15,0	20	75	78	93	XOKX 050204	SOKX 050204	P02004IP	XT06IP	☺
184332800	XCS 15520-5D	15,5	20	78	81	96	XOKX 050204	SOKX 050204	P02004IP	XT06IP	☺
184332900	XCS 16020-5D	16,0	20	80	83	98	XOKX 050204	SOKX 050204	P02004IP	XT06IP	☺
184333000	XCS 16525-5D	16,5	25	83	86	106	XOKX 060204	SOKX 060205	P02205IP	XT06IP	☺
184333100	XCS 17025-5D	17,0	25	85	88	108	XOKX 060204	SOKX 060205	P02205IP	XT06IP	☺
184333200	XCS 17525-5D	17,5	25	88	91	111	XOKX 060204	SOKX 060205	P02205IP	XT06IP	☺
184333300	XCS 18025-5D	18,0	25	90	93	113	XOKX 060204	SOKX 060205	P02205IP	XT06IP	☺
184333400	XCS 18525-5D	18,5	25	93	96	116	XOKX 060204	SOKX 060205	P02205IP	XT06IP	☺
184333500	XCS 19025-5D	19,0	25	95	98	118	XOKX 060204	SOKX 060205	P02205IP	XT06IP	☺
184333600	XCS 19525-5D	19,5	25	98	101	121	XOKX 060204	SOKX 060205	P02205IP	XT06IP	☺
184333700	XCS 20025-5D	20,0	25	100	103	123	XOKX 07T205	SOKX 07T208	P02507IP	XT08IP	☺
184333800	XCS 20525-5D	20,5	25	103	106	126	XOKX 07T205	SOKX 07T208	P02507IP	XT08IP	☺
184333900	XCS 21025-5D	21,0	25	105	108	128	XOKX 07T205	SOKX 07T208	P02507IP	XT08IP	☺
184334000	XCS 21525-5D	21,5	25	108	111	131	XOKX 07T205	SOKX 07T208	P02507IP	XT08IP	☺
184334100	XCS 22025-5D	22,0	25	110	113	133	XOKX 07T205	SOKX 07T208	P02507IP	XT08IP	☺
184334200	XCS 22525-5D	22,5	25	113	116	136	XOKX 07T205	SOKX 07T208	P02507IP	XT08IP	☺
184334300	XCS 23025-5D	23,0	25	115	118	138	XOKX 07T205	SOKX 07T208	P02507IP	XT08IP	☺
184334400	XCS 23525-5D	23,5	25	118	121	141	XOKX 07T205	SOKX 07T208	P02507IP	XT08IP	☺



☺ Stock item | Produto de stock | Itens de stock

○ Available under request | Disponível sobre consulta | Disponible bajo consulta

Continue next page

XCS 5D

Jet drills | Brocas jet | Brocas jet

Order code Código	Reference Referência Referencia	Dimensions Dimensões Dimensiones (mm)					Inner Insert	Outer Insert	Insert Screw 	Torx key 	Stock
		DC	DONMS	LU	LCF	LPR					
184334500	XCS 24032-5D	24,0	32	120	123	148	XOKX 090305	SOKX 090308	P03007IP	XT08IP	📦
184334600	XCS 24532-5D	24,5	32	123	126	151	XOKX 090305	SOKX 090308	P03007IP	XT08IP	📦
184334700	XCS 25032-5D	25,0	32	125	128	153	XOKX 090305	SOKX 090308	P03007IP	XT08IP	📦
184334800	XCS 25532-5D	25,5	32	128	131	156	XOKX 090305	SOKX 090308	P03007IP	XT08IP	📦
184334900	XCS 26032-5D	26,0	32	130	133	158	XOKX 090305	SOKX 090308	P03007IP	XT08IP	📦
184335000	XCS 26532-5D	26,5	32	133	136	161	XOKX 090305	SOKX 090308	P03007IP	XT08IP	📦
184335100	XCS 27032-5D	27,0	32	135	138	163	XOKX 090305	SOKX 090308	P03007IP	XT08IP	📦
184335200	XCS 27532-5D	27,5	32	138	141	176	XOKX 090305	SOKX 090308	P03007IP	XT08IP	📦
184335300	XCS 28032-5D	28,0	32	140	143	168	XOKX 090305	SOKX 090308	P03007IP	XT08IP	📦
184335400	XCS 28532-5D	28,5	32	143	146	171	XOKX 090305	SOKX 090308	P03007IP	XT08IP	📦
184335500	XCS 29032-5D	29,0	32	145	148	173	XOKX 090305	SOKX 090308	P03007IP	XT08IP	📦
184335600	XCS 29532-5D	29,5	32	148	151	176	XOKX 090305	SOKX 090308	P03007IP	XT08IP	📦
184335700	XCS 30032-5D	30,0	32	152	155	180	XOKX 11T306	SOKX 11T308	P03508IP	XT15IP-S35	📦
184335800	XCS 31032-5D	31,0	32	157	160	185	XOKX 11T306	SOKX 11T308	P03508IP	XT15IP-S35	📦
184335900	XCS 32032-5D	32,0	32	162	165	190	XOKX 11T306	SOKX 11T308	P03508IP	XT15IP-S35	📦
184336000	XCS 33032-5D	33,0	32	167	170	195	XOKX 11T306	SOKX 11T308	P03508IP	XT15IP-S35	📦
184336100	XCS 34032-5D	34,0	32	172	175	200	XOKX 11T306	SOKX 11T308	P03508IP	XT15IP-S35	📦
184336200	XCS 35032-5D	35,0	32	177	180	205	XOKX 11T306	SOKX 11T308	P03508IP	XT15IP-S35	📦
184336300	XCS 36040-5D	36,0	40	182	185	215	XOKX 130406	SOKX 130410	P04010IP	XT15IP-S35	📦
184336400	XCS 37040-5D	37,0	40	187	190	220	XOKX 130406	SOKX 130410	P04010IP	XT15IP-S35	📦
184336500	XCS 38040-5D	38,0	40	192	195	225	XOKX 130406	SOKX 130410	P04010IP	XT15IP-S35	📦
184336600	XCS 39040-5D	39,0	40	197	200	230	XOKX 130406	SOKX 130410	P04010IP	XT15IP-S35	📦
184336700	XCS 40040-5D	40,0	40	202	205	235	XOKX 130406	SOKX 130410	P04010IP	XT15IP-S35	📦
184336800	XCS 41040-5D	41,0	40	207	210	240	XOKX 130406	SOKX 130410	P04010IP	XT15IP-S35	📦
184336900	XCS 42040-5D	42,0	40	212	215	245	XOKX 130406	SOKX 130410	P04010IP	XT15IP-S35	📦
184337000	XCS 43040-5D	43,0	40	217	220	250	XOKX 150508	SOKX 150510	P05013IP	XT20IP-S40	📦
184337100	XCS 44040-5D	44,0	40	222	225	255	XOKX 150508	SOKX 150510	P05013IP	XT20IP-S40	📦
184337200	XCS 45040-5D	45,0	40	227	230	260	XOKX 150508	SOKX 150510	P05013IP	XT20IP-S40	📦
184337300	XCS 46040-5D	46,0	40	232	235	265	XOKX 150508	SOKX 150510	P05013IP	XT20IP-S40	📦
184337400	XCS 47040-5D	47,0	40	237	240	270	XOKX 150508	SOKX 150510	P05013IP	XT20IP-S40	📦
184337500	XCS 48040-5D	48,0	40	242	245	275	XOKX 150508	SOKX 150510	P05013IP	XT20IP-S40	📦
184337600	XCS 49040-5D	49,0	40	247	250	280	XOKX 150508	SOKX 150510	P05013IP	XT20IP-S40	📦
184337700	XCS 50040-5D	50,0	40	252	255	285	XOKX 150508	SOKX 150510	P05013IP	XT20IP-S40	📦
184343200	XCS 51040-5D	51,0	40	257	260	290	XOKX 180508	SOKX 180510	P05013IP	XT20IP-S40	📦
184343300	XCS 52040-5D	52,0	40	262	265	295	XOKX 180508	SOKX 180510	P05013IP	XT20IP-S40	📦
184343400	XCS 53040-5D	53,0	40	267	270	300	XOKX 180508	SOKX 180510	P05013IP	XT20IP-S40	📦
184343500	XCS 54040-5D	54,0	40	272	275	305	XOKX 180508	SOKX 180510	P05013IP	XT20IP-S40	📦
184343600	XCS 55040-5D	55,0	40	277	280	310	XOKX 180508	SOKX 180510	P05013IP	XT20IP-S40	📦
184343700	XCS 56040-5D	56,0	40	282	285	315	XOKX 180508	SOKX 180510	P05013IP	XT20IP-S40	📦
184343800	XCS 57040-5D	57,0	40	287	290	320	XOKX 180508	SOKX 180510	P05013IP	XT20IP-S40	📦
184343900	XCS 58040-5D	58,0	40	292	295	325	XOKX 180508	SOKX 180510	P05013IP	XT20IP-S40	📦
184344000	XCS 59040-5D	59,0	40	297	300	330	XOKX 180508	SOKX 180510	P05013IP	XT20IP-S40	📦
184344100	XCS 60040-5D	60,0	40	302	305	335	XOKX 180508	SOKX 180510	P05013IP	XT20IP-S40	📦

📦 Stock item | Produto de stock | Itens de stock

○ Available under request | Disponível sobre consulta | Disponible bajo consulta

SOKX OUTER INSERT



SOKX-MP



SOKX-MS

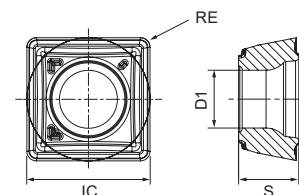

SOKX-MP | MS

Geometry code	ISO Reference	P			M		K			S		Dimensions Dimensões Dimensiones (mm)			
		PVD		CVD	PVD		PVD		CVD	PVD					
		T1	P4	2C	Y3	X9	T1	P4	2C	Y3	X9	IC	S	D1	RE
1142113	SOKX 050204-MP	⊗		⊗			⊗		⊗		5,10	2,50	2,40	0,40	
1142115	SOKX 060205-MP	⊗		⊗			⊗		⊗		6,20	2,60	2,60	0,50	
1142117	SOKX 07T208-MP	⊗		⊗			⊗		⊗		7,50	2,90	2,90	0,80	
1142119	SOKX 090308-MP	⊗		⊗			⊗		⊗		9,20	3,50	3,50	0,80	
1142121	SOKX 11T308-MP	⊗		⊗			⊗		⊗		11,00	4,20	4,10	0,80	
1142123	SOKX 130410-MP	⊗		⊗			⊗		⊗		13,00	4,73	4,60	1,00	
1142125	SOKX 150510-MP	⊗		⊗			⊗		⊗		15,20	5,30	5,60	1,00	
1142160	SOKX 180510-MP	⊗		⊗			⊗		⊗		18,20	5,30	5,60	1,00	
1142127	SOKX 050204-MS				⊗					⊗	5,10	2,50	2,40	0,40	
1142129	SOKX 060205-MS				⊗					⊗	6,20	2,60	2,60	0,50	
1142131	SOKX 07T208-MS				⊗					⊗	7,50	2,90	2,90	0,80	
1142133	SOKX 090308-MS				⊗					⊗	9,20	3,50	3,50	0,80	
1142135	SOKX 11T308-MS				⊗					⊗	11,00	4,20	4,10	0,80	
1142137	SOKX 130410-MS				⊗					⊗	13,00	4,73	4,60	1,00	
1142139	SOKX 150510-MS				⊗					⊗	15,20	5,30	5,60	1,00	
1142162	SOKX 180510-MS				⊗					⊗	18,20	5,30	5,60	1,00	

⊗ Stock item | Produto de stock | Itens de stock ○ Available under request | Disponível sob consulta | Disponible bajo consulta

Insert order code = ⁽¹⁾ Geometry code + ⁽²⁾ Grade code

INSERTS

Pastilhas | Plaquetas

XOKX INNER INSERT



XOKX-MP



XOKX-MS

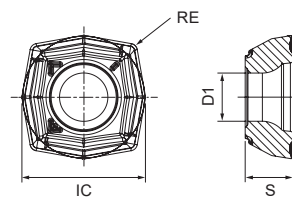

XOKX-MP | MS

		P		M		K		S		Dimensions Dimensões Dimensiones (mm)			
		PVD		PVD		PVD		PVD					
		⁽²⁾ Grade code		T1	P4	Y3	X9	T1	P4	Y3	X9	IC	S
⁽¹⁾ Geometry code	ISO Reference	PHP920	PHP930	PHH920	PHH930	PHP920	PHP930	PHH920	PHH930				
1142112	XOKX 050204-MP		⊗				⊗			5,40	2,50	2,40	0,40
1142114	XOKX 060204-MP		⊗				⊗			6,56	2,50	2,60	0,40
1142116	XOKX 07T205-MP		⊗				⊗			7,80	2,90	2,90	0,50
1142118	XOKX 090305-MP		⊗				⊗			9,60	3,50	3,50	0,50
1142120	XOKX 11T306-MP		⊗				⊗			11,38	4,15	4,10	0,60
1142122	XOKX 130406-MP		⊗				⊗			13,60	4,68	4,60	0,60
1142124	XOKX 150508-MP		⊗				⊗			15,90	5,30	5,60	0,80
1142159	XOKX 180508-MP		⊗				⊗			18,20	5,30	5,60	0,80
1142126	XOKX 050204-MS				⊗				⊗	5,40	2,50	2,40	0,40
1142128	XOKX 060204-MS				⊗				⊗	6,60	2,60	2,60	0,40
1142130	XOKX 07T205-MS				⊗				⊗	7,80	2,90	2,90	0,50
1142132	XOKX 090305-MS				⊗				⊗	9,60	3,50	3,50	0,50
1142134	XOKX 11T306-MS				⊗				⊗	11,38	4,20	4,10	0,60
1142136	XOKX 130406-MS				⊗				⊗	13,60	4,68	4,60	0,60
1142138	XOKX 150508-MS				⊗				⊗	15,90	5,30	5,60	0,80
1142161	XOKX 180508-MS				⊗				⊗	18,20	5,30	5,60	0,80

⊗ Stock item | Produto de stock | Itens de stock ○ Available under request | Disponível sob consulta | Disponible bajo consulta

Insert order code = ⁽¹⁾Geometry code + ⁽²⁾Grade code

SPARE PARTS Acessórios | Repuestos



Order Code	Reference	Torque (Nm)
290095800	P02004IP	0,4
290095900	P02205IP	0,8
290096000	P02507IP	0,8
290096100	P03007IP	1,2
290096200	P03508IP	3
290096300	P04010IP	3
290096400	P05013IP	5



XT

Order Code	Reference
290058600	CHAVE TORX XT06IP
290096500	CHAVE TORX XT08IP
290097300	CHAVE TORX XT15IP-S35
290097400	CHAVE TORX XT20IP-S40
290013200	XT20

CUTTING CONDITIONS Condições de corte | Condiciones de corte

ISO	Material Group	Vc (m/min)	fn (mm/rev)				
			Ø14-Ø16	Ø16,5-Ø23,5	Ø24-Ø29,5	Ø30-Ø42	Ø43-Ø60
P	Unalloyed steel (-0,25%)	160-250	0,04-0,08	0,04-0,08	0,04-0,10	0,05-0,12	0,05-0,14
	Low-alloy steel (0,25%-)	140-220	0,04-0,10	0,04-0,12	0,05-0,015	0,08-0,18	0,10-0,20
	Low-alloy steel	120-220	0,04-0,10	0,05-0,10	0,05-0,12	0,06-0,18	0,06-0,20
	High-alloy steel	120-180	0,04-0,12	0,05-0,12	0,07-0,16	0,08-0,18	0,08-0,20
M	Stainless steel	130-220	0,04-0,10	0,04-0,12	0,05-0,14	0,06-0,16	0,06-0,18
K	Grey cast iron	150-250	0,04-0,10	0,05-0,14	0,05-0,17	0,08-0,20	0,08-0,25
	Cast iron with nodular cast	100-200	0,04-0,12	0,04-0,12	0,05-0,14	0,06-0,15	0,06-0,18
S	Super-alloys and titanium	30-90	0,04-0,08	0,04-0,08	0,04-0,11	0,07-0,12	0,08-0,15

NOTES

When working on irregular surfaces, please reduce the feed rate by 30%-50%. To ensure the best performance, make sure to use the proper oil pressure (over 5kg/cm²) and follow the cutting data parameters.

Power requirements

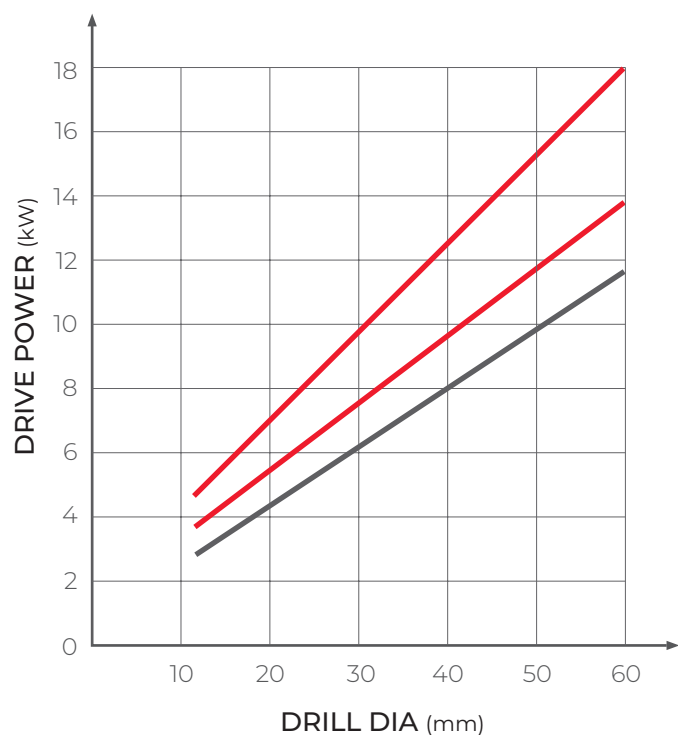

- F = 0,13 mm/r
- F = 0,10 mm/r
- F = 0,07 mm/r

Cutting oil quantity

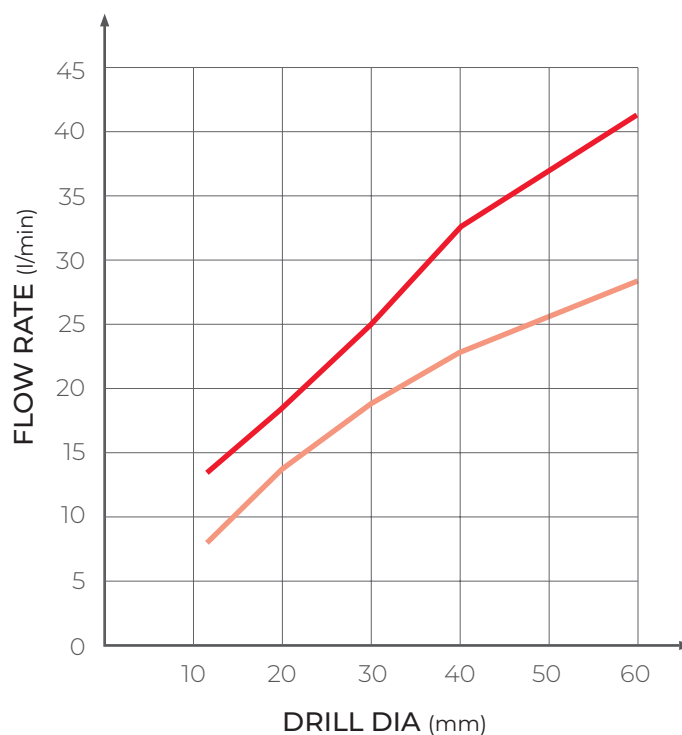

- Recommended cutting oil quantity
- Min. cutting oil quantity

NOTES

Minimum pressure coolant: 5bar

TEST REPORT Relatório de Teste | Informe de Prueba

Toolholder	Inserts	Workpiece	Cutting Conditions	Collant
XCS 17525-4D	SOKX 060205-MP PHS130; XOKX 060204-MP PHP930;	40 CrMnNiMo 8-6-4	Vc = 180m/min; fn = 0,11mm/rev; Drill depth = 65 mm;	Emulsion

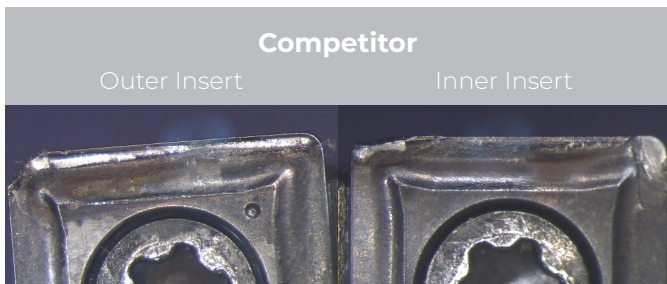
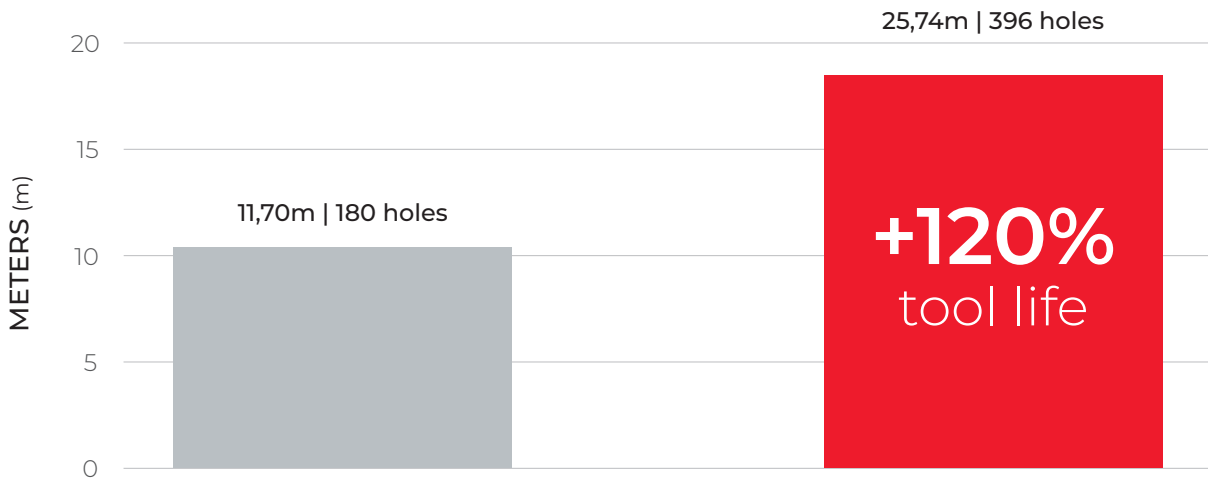

VIBRATIONS COMPARISON Comparação de vibrações | Comparación de vibraciones

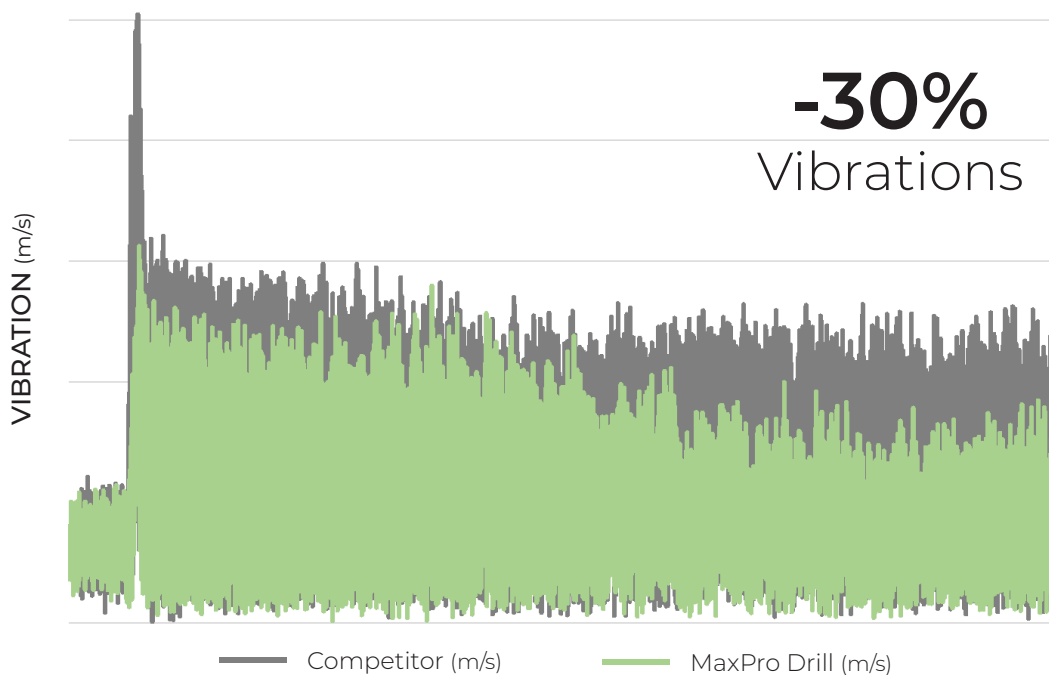

RADIAL ADJUSTMENT Ajuste radial | Ajuste radial

Drill diameter (Ø)	Diameter range (Ø)	Drill diameter (Ø)	Diameter range (Ø)	Drill diameter (Ø)	Diameter range (Ø)
Ø14,0	13,6~14,5	Ø28,0	27,4~28,6	Ø42,0	41,3~42,7
Ø14,5	14,1~15,0	Ø28,5	27,9~29,1	Ø42,5	41,8~43,2
Ø15,0	14,6~15,5	Ø29,0	28,4~29,6	Ø43,0	42,2~43,7
Ø15,5	15,1~16,0	Ø29,5	28,9~30,1	Ø43,5	42,7~44,2
Ø16,0	15,6~16,5	Ø30,0	29,3~30,7	Ø44,0	43,2~44,7
Ø16,5	16,0~17,0	Ø30,5	29,8~31,2	Ø44,5	43,7~45,2
Ø17,0	16,5~17,5	Ø31,0	30,3~31,7	Ø45,0	44,2~45,7
Ø17,5	17,0~18,0	Ø31,5	30,8~32,2	Ø45,5	44,7~46,2
Ø18,0	17,5~18,5	Ø32,0	31,3~32,7	Ø46,0	45,2~46,7
Ø18,5	18,0~19,0	Ø32,5	31,8~33,2	Ø46,5	45,7~47,2
Ø19,0	18,5~19,5	Ø33,0	32,3~33,7	Ø47,0	46,2~47,7
Ø19,5	19,0~20,0	Ø33,5	32,8~34,2	Ø47,5	46,7~48,2
Ø20,0	19,4~20,6	Ø34,0	33,3~34,7	Ø48,0	47,2~48,7
Ø20,5	19,9~21,1	Ø34,5	33,8~35,2	Ø48,5	47,7~49,2
Ø21,0	20,4~21,6	Ø35,0	34,3~35,7	Ø49,0	48,2~49,7
Ø21,5	20,9~22,1	Ø35,5	34,8~36,2	Ø49,5	48,7~50,2
Ø22,0	21,4~22,6	Ø36,0	35,3~36,7	Ø50,0	49,2~50,7
Ø22,5	21,9~23,1	Ø36,5	35,8~37,2	Ø51,0	50,2~51,7
Ø23,0	22,4~23,6	Ø37,0	36,3~37,7	Ø52,0	51,2~52,7
Ø23,5	22,9~24,1	Ø37,5	36,8~38,2	Ø53,0	52,2~53,7
Ø24,0	23,4~24,6	Ø38,0	37,3~38,7	Ø54,0	53,2~54,7
Ø24,5	23,9~25,1	Ø38,5	37,8~39,2	Ø55,0	54,2~55,7
Ø25,0	24,4~25,6	Ø39,0	38,3~39,7	Ø56,0	55,2~56,7
Ø25,5	24,9~26,1	Ø39,5	38,8~40,2	Ø57,0	56,2~57,7
Ø26,0	25,4~26,6	Ø40,0	39,3~40,7	Ø58,0	57,2~58,7
Ø26,5	25,9~27,1	Ø40,5	39,8~41,2	Ø59,0	58,2~59,7
Ø27,0	26,4~27,6	Ø41,0	40,3~41,7	Ø60,0	59,2~60,7
Ø27,5	26,9~28,1	Ø41,5	40,8~42,2		

GRADE SELECTION INNER INSERT

PVD

Due to the reduced cutting speed in the central area of the drill, a tougher grade is recommended for the inner insert.

PHP930
P20-P40
K10-K30

PHH930
M20-M40
S20-S30

GRADE SELECTION OUTER INSERT

PVD

First choice for stable machining and improved surface finish. Recommended for outer edge if chattering occurs.

PHP920
P10-P35
K10-K30

PHH920
M10-M25
S15-S30

CVD

First choice for high speeds and high efficiency machining, abrasion resistance and longer tool life.

PHS130
P10-P35
K20-K40

TECHNICAL INFORMATION FOR LATHE APPLICATIONS

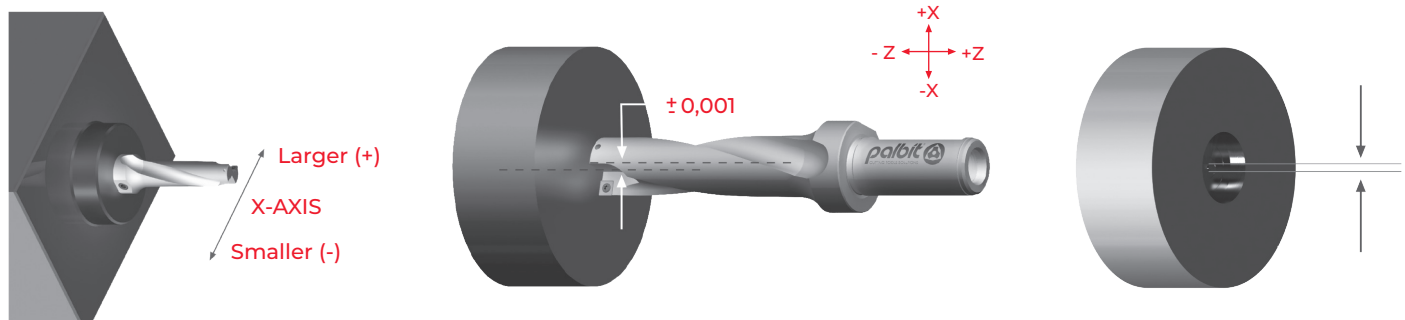

The cutting edge of insert should be parallel to X-axis to make it possible to do offset cutting. Since a flat part on shank for side lock clamping has been made parallel with the cutting edge line of insert, operator can set the drill as per flat part of shank.

The outer insert should be located in the direction (+) of X-axis to allow offset cutting and then the inner insert should face the operator.

To check up the setting of drill before use, test it by drilling about 5mm depth and then measure the core size if it is around 0,2mm - 0,7mm.

WARNING

In the course of through-hole operations, a slug or disc is formed as the tool breaks through the workpiece. When the drill is stationary while the workpiece is rotating, centrifugal force may eject this slug from the chuck. It is essential to have appropriate shielding in position to ensure the safety of bystanders.

BOTTOM OF BLIND HOLE Fundo do furo cego | Fondo del agujero ciego

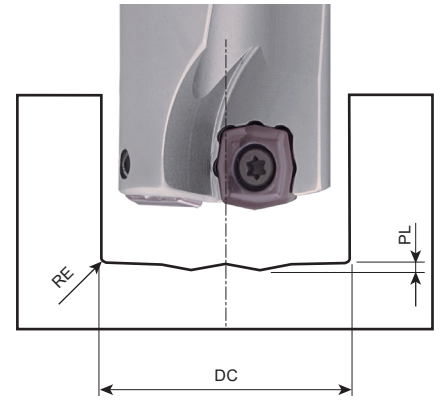

Drill diameter (mm)	Outer insert	Inner insert	PL	RE
Ø14,0-16,0	SOKX 050204	XOKX 050204	0,4	0,4
Ø16,5-19,5	SOKX 060205	XOKX 060205	0,5	0,5
Ø20,0-24,0	SOKX 07T208	XOKX 07T208	0,5	0,8
Ø24,5-30,0	SOKX 090308	XOKX 090308	0,7	0,8
Ø31,0-35,0	SOKX 11T308	XOKX 11T308	0,8	0,8
Ø36,0-42,0	SOKX 130410	XOKX 130410	1,0	1,0
Ø43,0-50,0	SOKX 150510	XOKX 150508	1,1	1,0
Ø51,0-60,0	SOKX 180510	XOKX 180508	1,2	1,0

RULES & TIPS Regras e dicas | Reglas y consejos

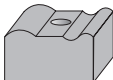
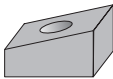
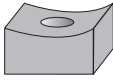
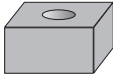
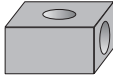
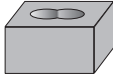
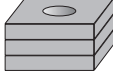
Workpiece	Machining
 Irregular surface	<ul style="list-style-type: none"> · Decrease the feed by 25%; · Potential chipping and fracture;
 Inclined surface	<ul style="list-style-type: none"> · Decrease the feed by 50%.
 Convex / Concave surface	<ul style="list-style-type: none"> · Decrease the feed by 50% until both inserts are engaged; · Potential initial contact with the central insert identified (convex surface);
 Boring	<ul style="list-style-type: none"> · Decrease the feed by 50%.
 Crossing holes	<ul style="list-style-type: none"> · Decrease the feed by 50% in the overlapped section.
 Chain holemaking	<ul style="list-style-type: none"> · Decrease the feed by 50%.
 Stack holemaking	<ul style="list-style-type: none"> · Decrease the feed by 25%; · Potential chipping and fracture;

Failure	Solution
 <p>Chattering</p>	<ul style="list-style-type: none">• Reduce the cutting speed and feed rate;• Ensure stable clamping;• Set the drill overhang;• Verify the machine torque;
 <p>Poor chip evacuation</p>	<ul style="list-style-type: none">• If long chip: Increase the cutting speed and feed rate.• If short chip: Reduce the cutting speed and feed rate, and increase the coolant pressure.
 <p>Poor surface quality</p>	<ul style="list-style-type: none">• Establish the cutting condition for improved chip control;• Reduce the feed rates or increase the cutting speed;• Increase the coolant flow and verify the coolant evacuation;• Shorten the overhang of the drill and ensure a more stable clamping;
 <p>Excessive wear or chipping</p>	<ul style="list-style-type: none">• Verify the cutting condition;• Increase the coolant flow and verify the coolant evacuation;• Shorten the overhang of the drill and ensure a more stable clamping;• Consider changing the insert grade;

2D | 3D | 4D | 5D

MAXPRO DRILL

Maximum performance to a great drilling experience



Check the QrCode for more information



HEADQUARTERS

PALBIT. S.A.

T (+351) 234 540 300 | F (+351) 234 540 301

palbit@palbit.pt | www.palbit.pt

Branch office

PALBIT México, S de RL de CV

T (+52) 5555 454 543 | F (+52) 5552 509 190

info@palbit.com.mx | www.palbit.pt/mx

Branch office

PALBIT Brasil

T (+55) 011 25 343 648

palbit@palbit.com.br | www.palbit.pt/br